

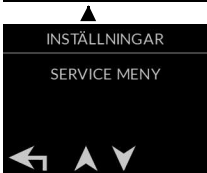

MODBUS Tekniska instruktioner

Ventilationsenheter utrustade med AHU-kontrollpanel kan styras och data kan samlas in från dem med hjälp av ett byggnadsautomationssystem som är kompatibelt med Modbus RTU, RS-485 kommunikationsbuss. Med automatiseringssystemet är det möjligt att styra ventilationsaggregatet och läsa av sensorvärdena. Samma information och styrmeter erhålls via Modbus-bussen som från kontrollpanelen.

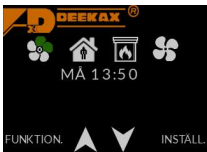

SVEP ÅT HÖGER FRÅN TOPPEN AV SKÄRMEN

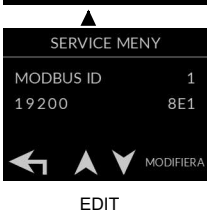
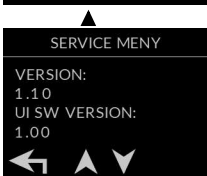
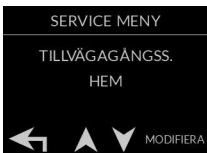

MODBUSINSTÄLLNINGAR

Modbus-inställningar väljs från kontrollpanelens servicemeny.

Följande bussinställningar för Modbus och RS-485 måste anges:

- Modbus-adress
- Baudhastighet
- Parity
- Stop-bit

SERVICE MENY

MODBUS ID 1

19200 8E1

← ↑ ↓ STALL

Adress 1...254

SERVICE MENY

MODBUS ID 1

19200 8E1

← ↑ ↓ STALL

Baudhastighet
9600/19200/38400

SERVICE MENY

MODBUS ID 1

19200 8E1

← ↑ ↓ STALL

PARITY STOP-BIT

8O1	odd parity	1
8E1	even parity	1
8N2	no parity	2
8N1	no parity	1

SERVICE MENY

FABRIKSINSTÄLLN. SPAR

← ↑ ↓ VÄLJ

Kopplingsschema

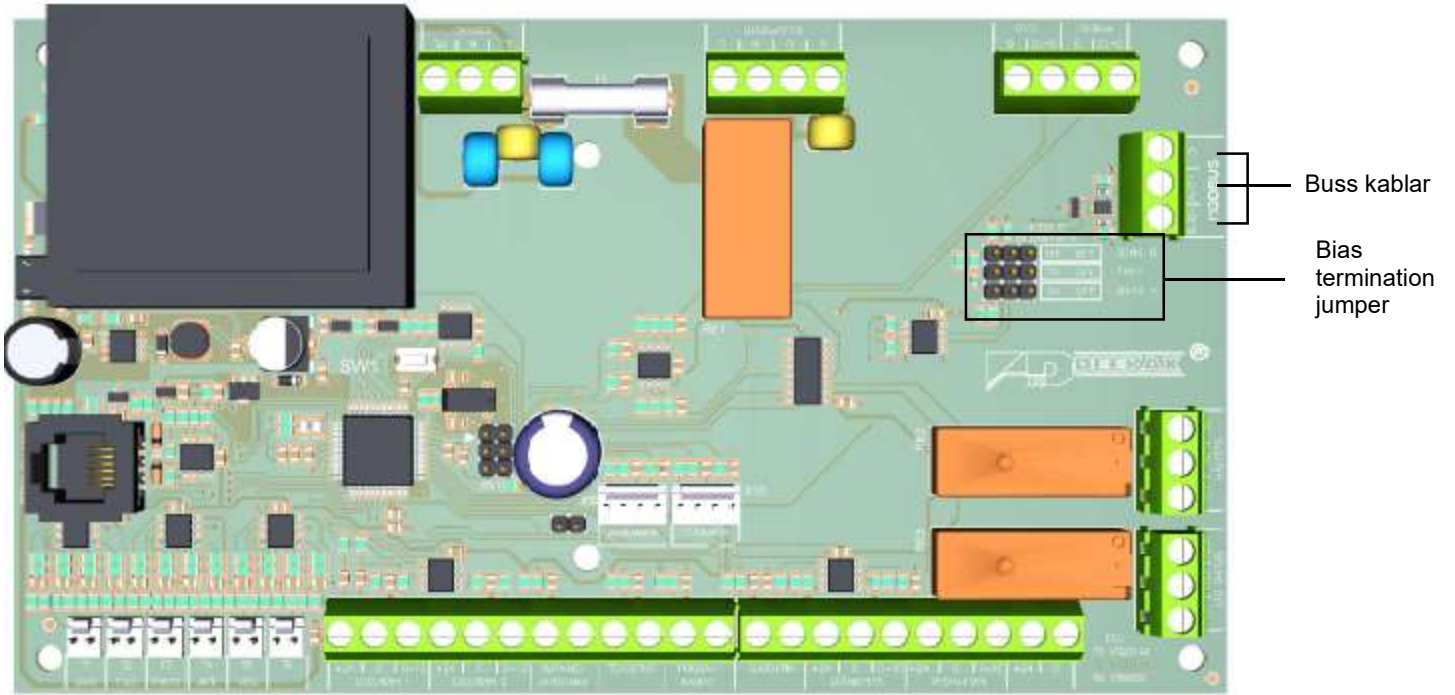

Enheten kan anslutas till RS485 Modbus-baserad buss.

Avslutning måste göras i bussens båda ändar (Modbus master och bussens sista enhet). Biasing görs i en enda enhet, vanligtvis i en Modbus-master. Det bör endast användas på dessa kort om Modbus-master inte gör det. Bussen måste vara seriell, inte ett stjärnätverk.

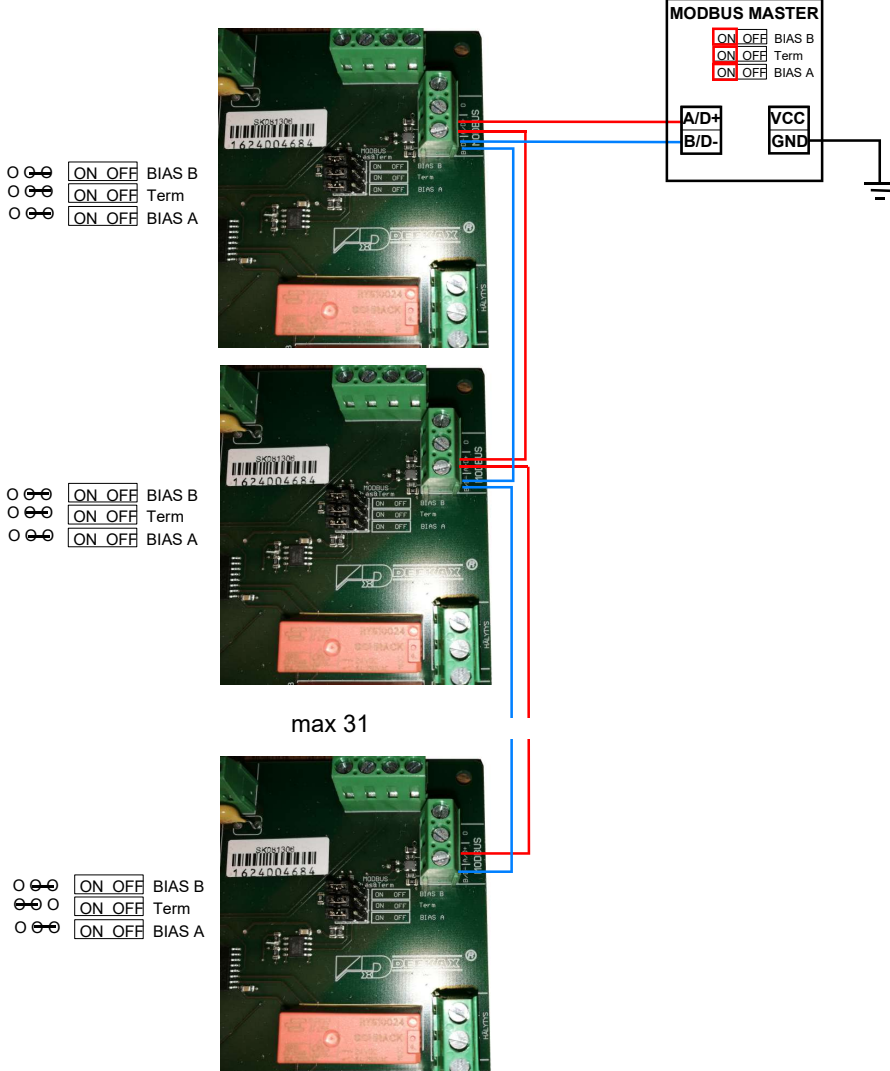

Input register 16 bit integer register Read only

Modbus	Register Name	Min	Max	Unit	Description
Application control registers					
3x00001	Outdoor temperature			0.1°C	
3x00002	Supply air temperature			0.1°C	
3x00003	Exhaust air temperature			0.1°C	
3x00004	Waste air temperature			0.1°C	
3x00005	Water temperature			0.1°C	
3x00006	T6				
3x00007	A1 input state				Depends on configuration. RH: 0.1%, CO2: 0.1 PPM, Others: 10 mV
3x00008	A2 input state				
3x00009	Supply fan step				
3x00010	Exhaust fan step				
3x00011	Heat exchange state				0 = Winter, 1 = Summer
3x00012	Alarm state				0 = No alarms, 1 = Alarm
3x00013	Pot. card: Summer bypass			°C	
3x00014	Pot. card: Fan balance			0.1 V	
3x00015	Pot. card: Pre heater temp.			°C	
3x00016	Pot. card: Supply air setting			0.1°C	
3x00017	Afterheater power				Range [0..40]
3x00018	Preheater power				Range [0..40]
3x00019	Boosting because of A1				In steps
3x00020	Boosting because of A2				In steps
3x00021	Waste cold				0 = no, 1 = yes
3x00022	Supply cold				0 = no, 1 = yes
3x00023	Supply hot				0 = no, 1 = yes
3x00024	Water cold				0 = no, 1 = yes
3x00025	Maintenance needed				0 = no, 1 = yes
3x00026	Away mode				0 = no, 1 = yes
3x00027	Remote allow run				0 = no, 1 = yes
3x00028	Overpressure time left			sec	
3x00029	Boosting time left			sec	
3x00030	Supply fan voltage			0.1 V	
3x00031	Exhaust fan voltage			0.1 V	
Sensor status					
3x00101	Outdoor sensor				0 = Error, 1 = Ok
3x00102	Supply air sensor				0 = Error, 1 = Ok
3x00103	Exhaust air sensor				0 = Error, 1 = Ok
3x00104	Waste air sensor				0 = Error, 1 = Ok
3x00105	Water sensor				0 = Error, 1 = Ok
3x00106	T6				0 = Error, 1 = Ok
3x00107	A1 sensor				0 = Error, 1 = Ok
3x00108	A2 sensor				0 = Error, 1 = Ok
3x00109	Afterheater				0 = Error, 1 = Ok
3x00110	Preheater				0 = Error, 1 = Ok

Input register 16 bit integer register Read only

Error counters					
3x00201	Outdoor sensor				
3x00202	Supply air sensor				
3x00203	Exhaust air sensor				
3x00204	Waste air sensor				
3x00205	Preheater				
3x00206	Afterheater				
3x00207	Supply cold				
3x00208	Supply hot				
3x00209	Waste cold				
3x00210	Filter				
3x00211	Internal error				
3x00212	A1 sensor				
3x00213	A2 sensor				
3x00214	Water sensor				
3x00215	Boot count				
3x00216	Maintenance time				

Holding register 16 bit integer register R/W

Modbus	Register Name	Min	Max	Unit	Description
Settings and control registers					
4x00001	Overpressure On	0	1		0 = Off, 1 = On
4x00002	Boosting On	0	1		0 = Off, 1 = On
4x00003	Away mode On	0	1		0 = Off, 1 = On
4x00005	Supply fan speed	1	5		
4x00006	Fan balance	0	0		Obsolete, use 4x0039 - 4x0048
4x00007	Supply temperature setting	5	30	°C	
4x00008	Preheater limit	0	10	°C	
4x00009	CO2 boost enable	0	1		0 = Disable, 1 = Enable
4x00010	CO2 limit	250	1500	PPM	
4x00011	RH boost enable	0	1		0 = Disable, 1 = Enable
4x00012	RH limit	30	80	%RH	
4x00013	Boost adjust period	5	20	min	
4x00014	Overpressure time	0	30	min	0 = Until signal absent
4x00015	Boosting time	0	120	min	0 = Until signal absent
4x00016	Summer bypass	0	2		0 = Auto, 1 = Summer, 2 = Winter
4x00017	Summer bypass temperature	15	20	°C	
4x00018	Waste cold limit	-10	10	°C	
4x00019	Supply cold limit	-10	15	°C	
4x00020	Supply hot limit	30	40	°C	
4x00021	Afterheater type	0	1		0 = Electric, 1 = Water
4x00022	Water cold limit	0	10	°C	0 = Disable, 5-10 = normal setting.
4x00023	Preheater installed	0	1		0 = No, 1 = Yes
4x00024	Aftercooler installed	0	1		0 = No, 1 = Yes
4x00025	Aftercooler enabled	0	1		0 = Disable, 1 = Enable
4x00026	Afterheater enabled	0	1		0 = Disable, 1 = Enable
4x00027	Overpressure quantity	1	4	steps	
4x00028	Boosting quantity	1	4	steps	
4x00029	A1 Type	0	3		0 = None, 1 = CO2 sensor, 2 = RH sensor, 3 = External control
4x00030	A2 Type	0	3		
4x00031	Extended time	30	120	min	
4x00032	Extended time on	0	1		0 = No, 1 = Yes
4x00033	Maintenance period	0	12	month	
4x00034	Filter pressure enabled	0	1		0 = Disable, 1 = Enable
4x00035	Remote allow enabled	0	1		0 = Disable, 1 = Enable Notice! For contact information control
4x00036	Pot card used	0	1		0 = No, 1 = Yes
4x00037	Language index	0	3		0 = Fin, 1 = Swe, 2 = Est, 3 = Eng
4x00038	Operation mode(START/STOP)	0	1		0 = Home(START), 1 = Office(STOP)
4x00039	Supply fan step 1	10	100	0.1V	
4x00040	Supply fan step 2	10	100	0.1V	
4x00041	Supply fan step 3	10	100	0.1V	
4x00042	Supply fan step 4	10	100	0.1V	
4x00043	Supply fan step 5	10	100	0.1V	
4x00044	Exhaust fan step 1	10	100	0.1V	
4x00045	Exhaust fan step 2	10	100	0.1V	
4x00046	Exhaust fan step 3	10	100	0.1V	
4x00047	Exhaust fan step 4	10	100	0.1V	
4x00048	Exhaust fan step 5	10	100	0.1V	

Holding register 16 bit integer

Clock

4x00091	Hours	0	23	
4x00092	Minutes	0	59	
4x00093	Day of week	0	6	0 = Monday, 6 = Sunday

Weekclock

4x00101	Week program 1, enabled	0	1	0 = No, 1 = Yes
4x00102	Week program 1, weekdays	0	127	Bitfield, bit 0 = Monday, bit 6 = Sunday
4x00103	Week program 1, start time	0	1425	Minutes after midnight, must be multiple of 15.
4x00104	Week program 1, stop time	0	1425	
4x00105	Week program 1, fan speed	0	5	Fan speed
4x00106	Week program 2, enabled	0	1	See Week program 1 above
4x00107	Week program 2, weekdays	0	127	
4x00108	Week program 2, start time	0	1425	
4x00109	Week program 2, stop time	0	1425	
4x00110	Week program 2, fan speed	0	5	
4x00111	Week program 3, enabled	0	1	
4x00112	Week program 3, weekdays	0	127	
4x00113	Week program 3, start time	0	1425	
4x00114	Week program 3, stop time	0	1425	
4x00115	Week program 3, fan speed	0	5	
4x00116	Week program 4, enabled	0	1	
4x00117	Week program 4, weekdays	0	127	
4x00118	Week program 4, start time	0	1425	
4x00119	Week program 4, stop time	0	1425	
4x00120	Week program 4, fan speed	0	5	
4x00121	Week program 5, enabled	0	1	
4x00122	Week program 5, weekdays	0	127	
4x00123	Week program 5, start time	0	1425	
4x00124	Week program 5, stop time	0	1425	
4x00125	Week program 5, fan speed	0	5	